

# MULTIPANEL

## Balcony Substrate

## Waterproofing System

### INSTALLATION GUIDE

Sheet size (MM)	Thickness	Weight	Weight/ M <sup>2</sup>	"R" value (M <sup>2</sup> -K/W)
2400 x 1200	30mm	18Kg	6.25Kg	1.11
2400 x 1200	16mm	9.2Kg	3.19Kg	0.59

All edges of sheets are tongue and grooved for installation convenience and minimising waste.

### Application

MULTIPANEL is 100% waterproof, making it an ideal substrate for external residential balconies.

This guide will outline two methods of detailing a balcony flooring substrate to achieve a 100% waterproof finish. 30mm MULTIPANEL can be installed direct to 300mm joist centres or alternatively 16mm MULTIPANEL can be installed to an existing solid substrate.

### Adhesion

MULTIPANEL recommends polyurethane adhesive, in conjunction with mechanical fixing, when gluing panels to substrates. The MULTIPANEL PU is recommended and is the preferred method for adhering to framework. For alternate adhesives refer to manufacturers specifications.

### A and B surfaces of MULTIPANEL

During the manufacturing process some air pockets may form. These air bubbles are small in size and appear on the "B" side of the panel only. Every panel produced is stamped to advise the "B" side. Holes will not compromise the integrity or waterproofing of the system.

### Cutting

Standard woodworking tools can be used for all cutting of MULTIPANEL.

### Storage and handling

MULTIPANEL should always be stored flat, on a level surface, and away from direct sunlight. UV light will cause discolouration of MULTIPANEL however will not change the structural integrity.

### Safety

MULTIPANEL is an inert, non-toxic, non-carcinogenic material and is not considered harmful, however inhalation of dust produced during cutting should be avoided.

Eye, ear and mouth protection should be worn whenever cutting or sanding MULTIPANEL. Gloves are recommended when applying MULTIPANEL adhesive.

Uncured adhesive may be removed from tools and timber and tiles with alcohol cleaner such as Methylated spirits. Cured adhesive must be removed mechanically.

\*Where the document refers to **FMP100 & FMP100-PU** this is now known as **MULTIPANEL Foaming Adhesive**

\*Where the document refers to **FIX30 & FIX30-PU** this is now known as **MULTIPANEL Sealant**

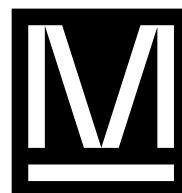









### What is MULTIPANEL?

MULTIPANEL manufactures a revolutionary, high-density, polyurethane composite building panel, ideal for waterproofing bathrooms and wet areas as it is lightweight, 100% waterproof, highly versatile and replaces the need for a liquid membrane.

This innovative product is currently the most technologically advanced construction panel on the global market. It is a significantly superior alternate to traditional building materials.

### PRODUCT ADVANTAGES

- / Lightweight
- / 100% waterproof
- / Eco-Friendly
- / Labour Saving
- / Insulating

Component	Description
<b>Supplied by MULTIPANEL</b>	
 <b>Foaming PU adhesive*</b>	MULTIPANEL Foaming Adhesive*, 310mL Colour: Opaque
 <b>PU adhesive*</b>	MULTIPANEL Sealant Adhesive*, 600mL Colour: Brown
 <b>T&amp;G router bit</b>	For creating tongue and groove joint detail
<b>Not Supplied by MULTIPANEL</b>	
 <b>Screws</b>	For fixing into steel frame. Minimum 40mm screw
 <b>Screws</b>	For fixing into timber frame 2.8 x 50mm min class 3 fixing Refer to manufacturers for suitability
 <b>Flashing screws</b>	10-16 x 16mm Self-Drilling screw, Wafer, Class 3
 <b>Nails</b>	Nails – min class 3 2.8 x 50mm
 <b>Blade</b>	For spreading adhesive over all sheet joints and fixings
 <b>Gloves</b>	Recommended when using adhesive

## DESIGN CONSIDERATIONS

### FRAMING

MULTIPANEL Exterior Flooring must be fixed to timber or steel joists installed at 300mm max centres.

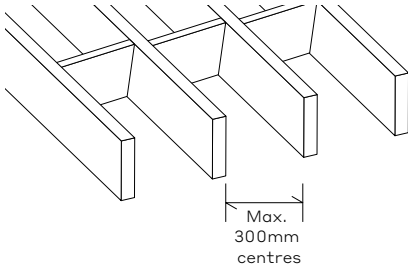

### TIMBER FRAMING

Timber framing must be in accordance with AS 1684 – 'Residential timber-framed construction', the building code of Australia and the framing manufacturer's specifications.

Adequate ventilation in the floor space is recommended.

### STEEL FRAMING

Steel framing must be in accordance with AS 3623 – 'Domestic metal framing' and the framing manufacturer's specifications.

### TOLERANCES

Framing must be straight and true. Framing tolerances must comply with relevant codes and manufacturer's specifications.

### LOADING

30mm MULTIPANEL floor sheets are structurally designed to withstand the domestic and residential activities for self-contained dwellings (Category A1) of Table 3.1 of AS/ NZS 1170.1 – 'Structural design actions – Permanent, imposed and other actions' of 1.8kN concentrated load and a UDL (Uniformly Distributed Load) capacity of 5kPa at a maximum 300mm floor joist centre's.

### DRIP LINE AND BOX GUTTER DETAIL

Router out two slots to achieve a drip line with a box gutter. First slot is drip line. Second slot to fit over box gutter edge with MULTIPANEL Sealant.

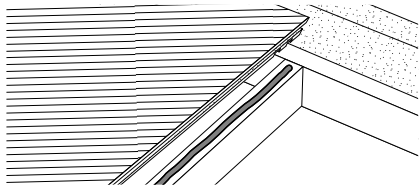

### TILING

Install tiles as per AS 3958.1-2007. When tiling, please ensure a compatible polyurethane tile adhesive is used. For a list of recommended adhesives visit [www.multipanel.com.au](http://www.multipanel.com.au) or call MULTIPANEL on (03) 9787 2544.

## WALL/FLOOR JUNCTION

A minimum 70mm MULTIPANEL upstand is required.\* Apply MULTIPANEL Foaming Adhesive in a continuous 3mm bead to the subframe and the underside of the upstand to fix to MULTIPANEL flooring substrate as shown in diagram.

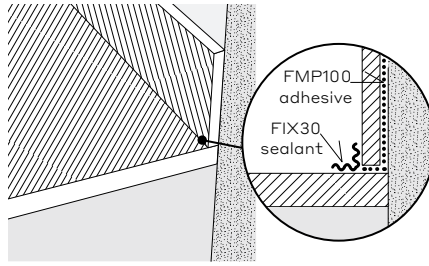

### ALTERNATE FLASHING DETAIL

Use minimum 70mm x 50mm metal flashing to seal the corner using MULTIPANEL Sealant Adhesive as shown in diagram below.

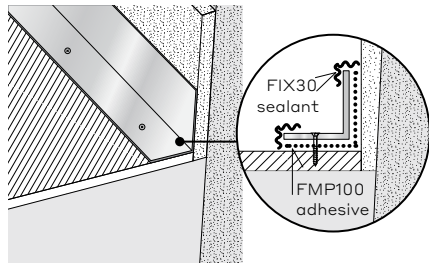

\*The thickness of the MULTIPANEL upstand is dependant on the support structure behind it. A minimum 16mm MULTIPANEL upstand is required when wall frame spacings are at 450mm centres. If adhering MULTIPANEL upstands to a solid surface, any thickness MULTIPANEL can be used to suit the overall wall finish.

NOTE – Fix metal flashing with 20mm maximum screws into 30mm MULTIPANEL and 10mm maximum screws into 16mm MULTIPANEL spaced every 300mm.

### FALL/DRAINAGE

Decks must have a fall to facilitate drainage. Decks must have a fall of at least 1 in 100 away from the building. Floor joists must run in the direction of the fall. Do not provide fall by packing sheets. The fall can be created by trimming or sloping the joists.

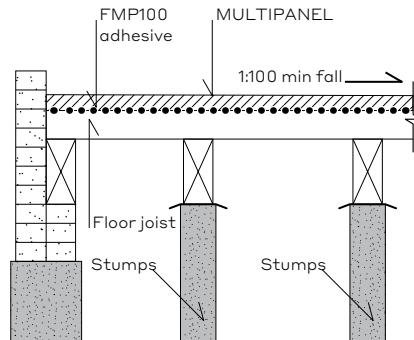

Outer edge of panel to extend over the edge of the balcony or into a box gutter.

In some applications, MULTIPANEL can be graded to form a central waste outlet, for more information contact MULTIPANEL on +61 3 9787 2544.

## BALUSTRADE

The balustrade upright supports must be fixed to the structural frame and not to the MULTIPANEL Exterior flooring. Ensure that all fixings and penetrations are sealed using MULTIPANEL Sealant Adhesive around the base support of the balustrade.

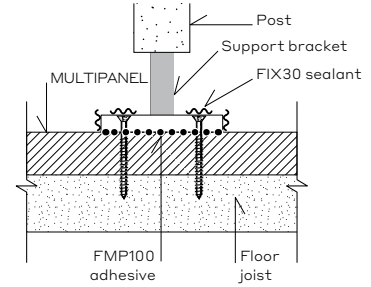
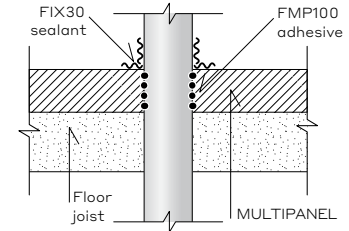

### EDGE DETAIL USING MULTIPANEL

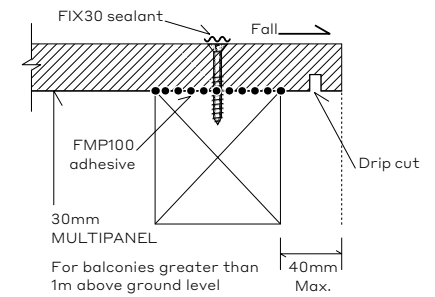

### EDGE DETAIL USING PAINT RENDER FINISH

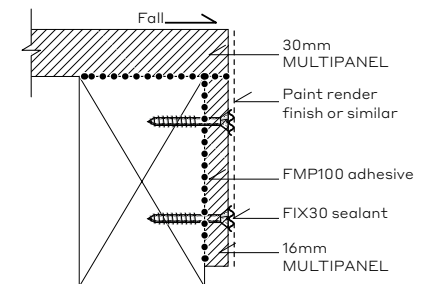

### EDGE DETAIL USING PAINT RENDER FINISH – 16MM ALTERNATIVE

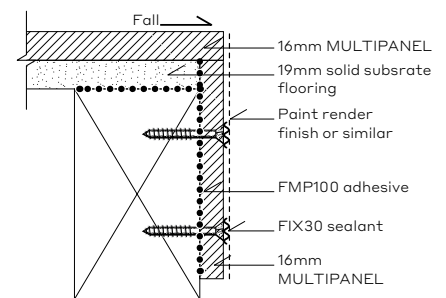

**EDGE DETAIL USING TILE**

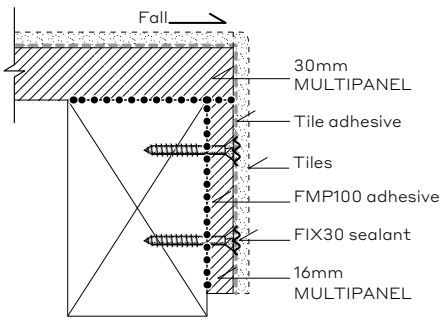

**WALL/FLOOR JUNCTION**

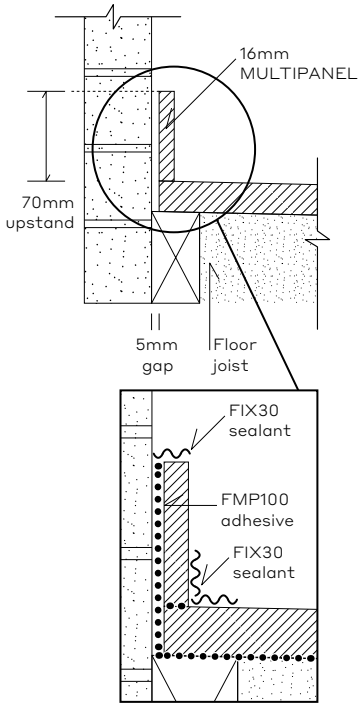

**WALL TO DECK FLASHING**

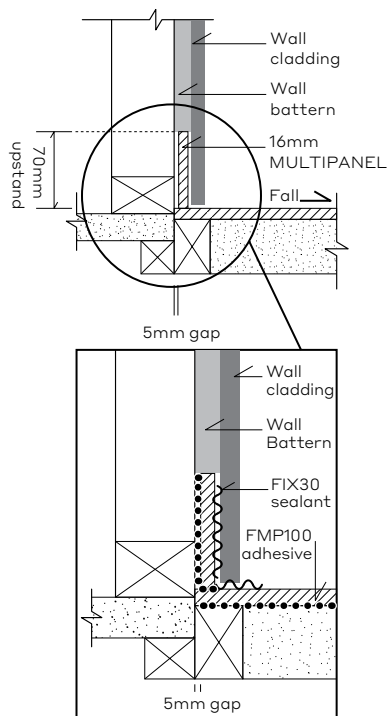

**INSTALLATION STEPS**

**Step 1**

**PANEL LAYOUT**

Brick staggered panel layout

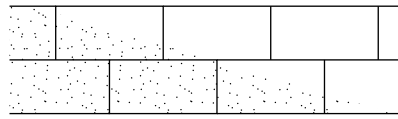

Squared panel layout

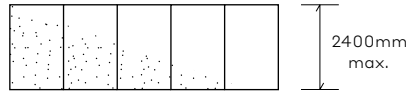

MULTIPANEL can either be installed in a brick staggered panel layout or a squared panel layout if the balcony is 2400mm or less as shown above.

\* MULTIPANEL can be joined off joist however adhesive must be fully cured before any weight is applied to joint.

**Step 2**

**SURFACE PREPARATION**

Apply MULTIPANEL Foaming Adhesive, in a continuous 3mm bead along all supporting beams.

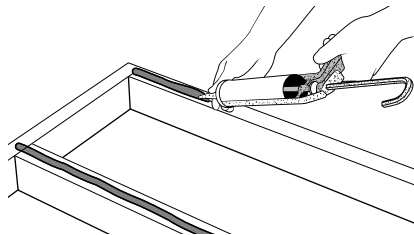

**Step 3**

**INSTALLING FIRST SHEET**

Remove tongue and install the flat edge against the wall, to allow the second sheet to fit into the groove.

\*\* The last row of fasteners adjacent to the next Panel should be fixed later.

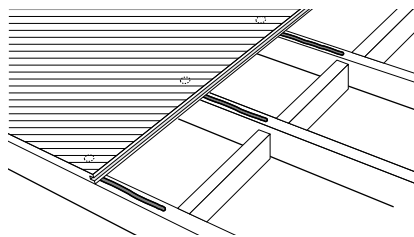

**FASTENER LAYOUT**

Min 30mm from T&G edge

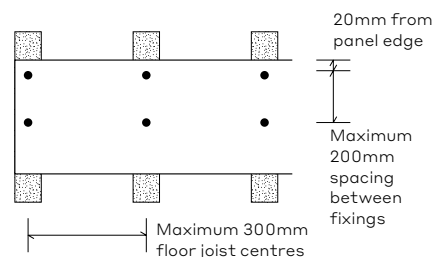

**Step 4**

**INSTALLING SECOND PANEL**

Apply MULTIPANEL Foaming Adhesive, in a continuous 3mm bead, to both sides of the tongue. Install second Panel, and fix off remaining fasteners from the previous panel.

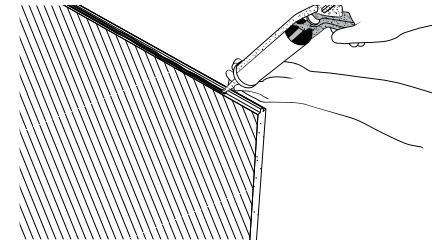

**Step 5**

**WATERPROOFING THE JOINS**

Blade off excess adhesive over the joints. Allow MULTIPANEL Foaming Adhesive three (3) hours to cure.

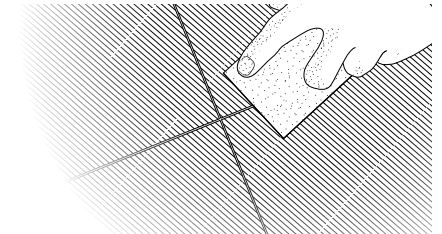

NOTE – This process needs to be repeated 2-3 times or until the MULTIPANEL Foaming Adhesive has finished expanding.

**Step 6**

**WATERPROOFING THE JOINS/FASTENERS**

Apply a 50mm band of MULTIPANEL Sealant along the sheet joints and blade off adhesive to achieve a smooth finish. Also apply MULTIPANEL Sealant over all fixings and penetrations.

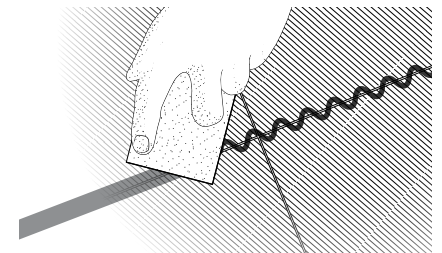

## DESIGN COMPLIANCE

All design and construction must comply with the appropriate requirements of the current Building Code of Australia (BCA) and other applicable regulations and standards current at the time of construction.

It is the responsibility of the specifier to carry out the necessary design and detailing to ensure the waterproofing and finish, satisfy all relevant codes, regulations and system waterproofing manufacturer recommendations.

### DOOR SILL

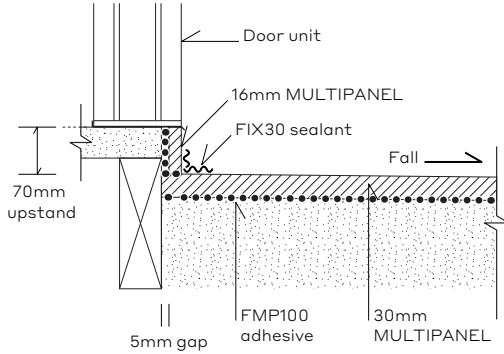

### STEP DOWN

A 70mm step down is suitable for locations with a wind class of N1, N2 or N3. A larger step down may be required for other locations (refer to the Building Code of Australia or the relevant building surveyor for further information).

Where a window or door sill butts the wall upstand or flashing, the sill is to be flashed or sealed in accordance with the manufacturer's installation instructions. The following diagrams provide examples of typical installations.

### DOOR SILL – WITH METAL FINISH

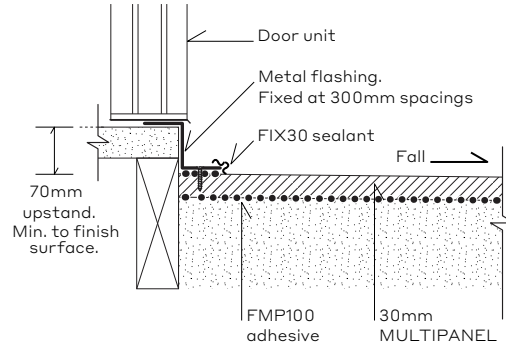

## ALTERNATIVE OPTION – 16MM MULTIPANEL ON TOP OF SOLID SUBSTRATE

### Step 1

Ensure a sound working platform is installed in accordance with AS/NZS 1170.1 – 'Structural design actions'.

NOTE – Prepare surface ensuring substrate is free from dust and debris.

### Step 2

#### PANEL LAYOUT

Ensure sheets are installed in a brick staggered panel layout or a squared panel layout if the balcony is 2400mm or less as shown below.

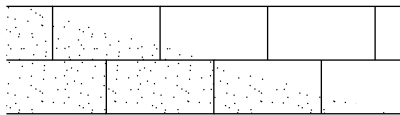

Squared panel layout

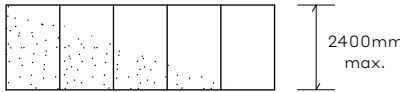

\* MULTIPANEL can be joined off joist however adhesive must be fully cured before any weight is applied to joint.

### Step 3

#### SURFACE PREPARATION

Apply MULTIPANEL Foaming Adhesive in a continuous 3mm bead and in a 300 x 300mm grid pattern as shown above.

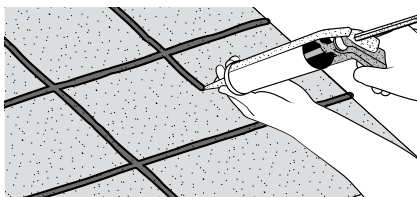

### Step 4

#### INSTALLING FIRST SHEET

Remove tongue and install the flat edge against the wall, to allow the second sheet to fit into the groove.

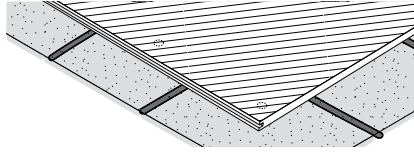

\*\* The last row of fasteners adjacent to the next Panel should be fixed later.

#### FASTENER LAYOUT

Min 30mm from T&G edge

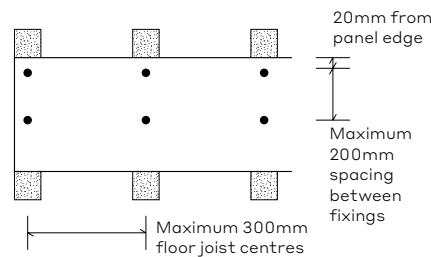

### Step 5

#### INSTALLING SECOND PANEL

Apply MULTIPANEL Foaming Adhesive, in a continuous 3mm bead, to both sides of the tongue. Install second Panel, and fix off remaining fasteners from the previous panel.

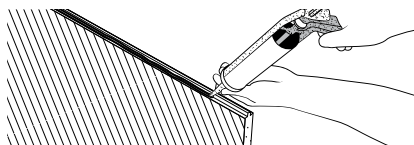

### Step 6

#### WATERPROOFING THE JOINS

Blade off excess adhesive over the joints. Allow MULTIPANEL Foaming Adhesive three (3) hours to cure.

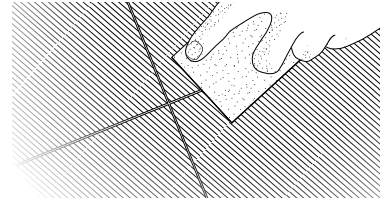

NOTE – This process needs to be repeated 2-3 times or until the MULTIPANEL Foaming Adhesive has finished expanding.

### Step 7

#### WATERPROOFING THE JOINS/FASTENERS

Apply a 50mm band of MULTIPANEL Sealant along the sheet joints and blade off adhesive to achieve a smooth finish. Also apply MULTIPANEL Sealant over all fixings and penetrations.

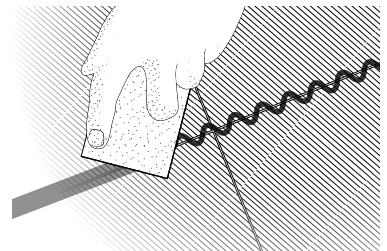

# MULTIPANEL Balcony Substrate Waterproofing System

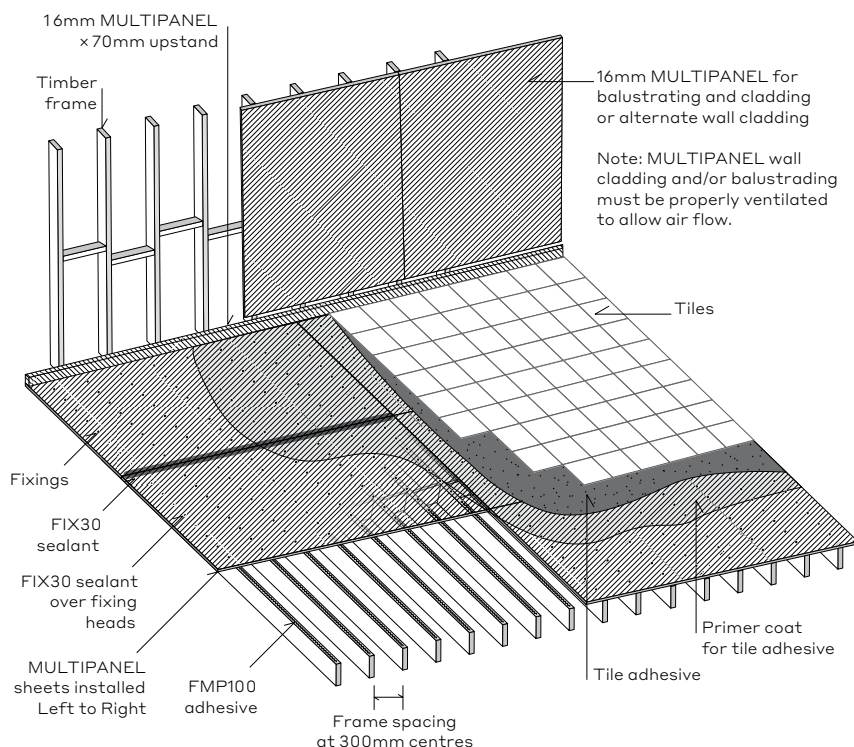

## WARRANTY AND CONDITIONS

The company warrants the MULTIPANEL Waterproof Balcony ("the product") for period of (10) years ("the warranty period") from the date of purchase, that it will be free from defects due to faulty manufacturing, and will be resistant to cracking, rotting, water, fire, and damage to the extent set out in the relevant MULTIPANEL published literature, and subject to compliance to the conditions set out below.

### CONDITIONS OF WARRANTY

The warranty is strictly subject to the following conditions (which are in addition to and do not displace the MULTIPANEL Terms and Conditions of Sale).

- The product and any other components of the system must be installed in accordance with the relevant MULTIPANEL literature current at the time of installation. Further to all other products including jointing and sealing systems, that are applied or used in conjunction with the product must be installed as per the relevant manufacturer's specifications at the time of installation.
- MULTIPANEL will not be liable for, and will not accept any breach of Warranty claims, unless the claimant provides proof of purchase within 30 days of the alleged defect becoming apparent.
- Under no circumstances is the Warranty transferable.
- MULTIPANEL will not be liable for defects arising from materials and components not supplied by MULTIPANEL, or the use of goods by a person in a manner not consistent with the recommendations made by MULTIPANEL.
- A claimant's sole remedy for breach of Warranty is (at the company's option) that MULTIPANEL will repair or replace the defect, pay the cost of replacement or rectification of the affected product, or supply replacement product.
- Under no circumstances will MULTIPANEL be liable for any damages or losses to property damage and personal injury, economic loss or loss of profits, arising from contract or negligence or howsoever arising. Without limiting the foregoing, MULTIPANEL will not be liable for any claims, damages or defects arising or in any way attributable to poor or defective workmanship, poor design and detailing, defective materials, structural movement and/or movement of materials to which the product is attached to, acts of God including but not limiting to severe weather conditions or unusual climate conditions, normal wear and tear, or growth of any organism on the product.

### DISCLAIMER

The recommendations in this literature are based on good building practice, but is not an exhaustive statement of all relevant information as the successful performance of the system depends on several factors outside the control of MULTIPANEL, for example the quality of workmanship and design.

### MULTIPANEL Pty Ltd

Phone +61 3 9787 2544  
Email [info@multipanel.com.au](mailto:info@multipanel.com.au)

[multipanel.com.au](http://multipanel.com.au)

# MULTIPANEL



Certificate CM20270 Rev 2